

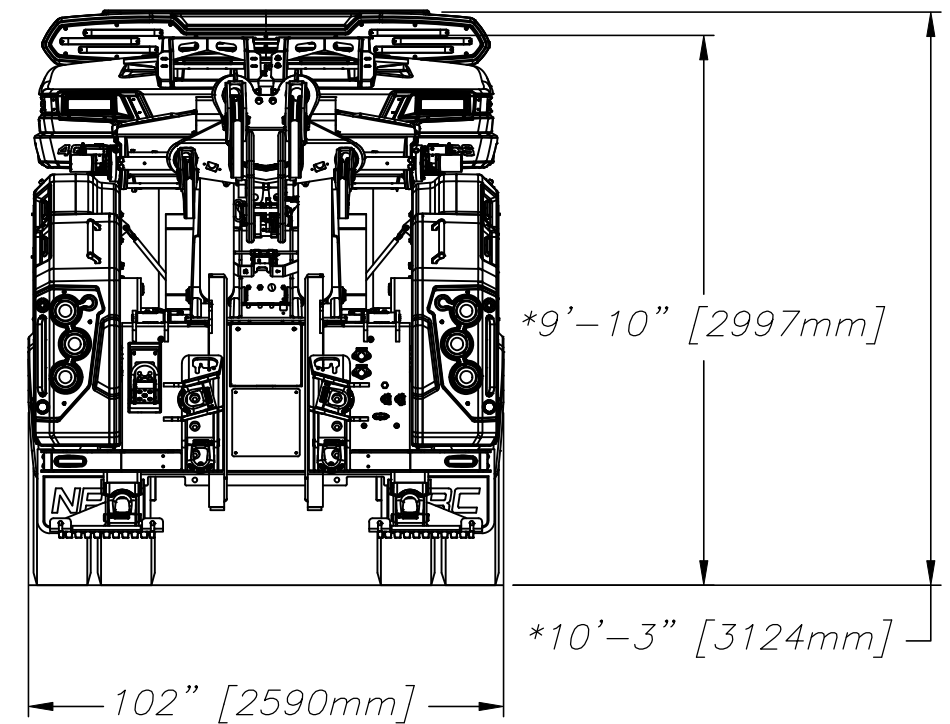

Model - Modèle: 40CS

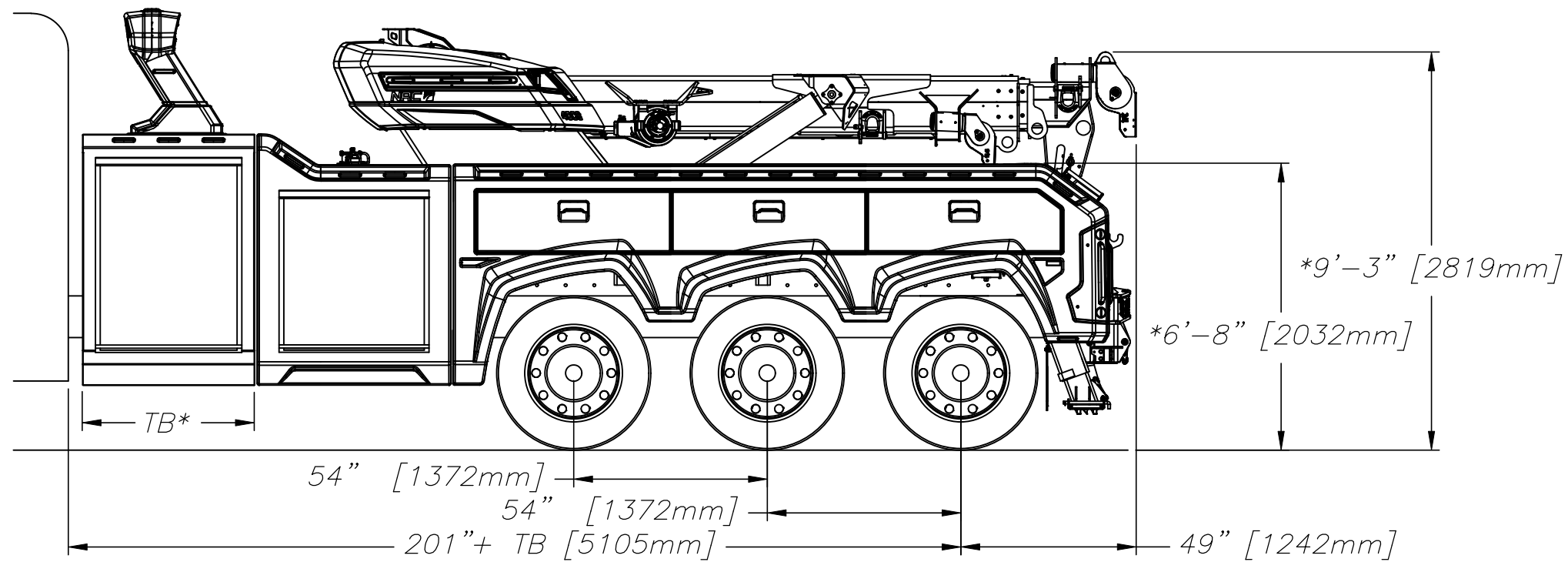

**TUNNEL TOOL BOX OPTIONAL, MINIMUM 28" & MAXIMUM 72"
COFFRE TUNNEL OPTIONNEL, MINIMUM 710mm & MAXIMUM 1830mm*

**BASED ON 43" FRAME HEIGHT
BASÉ SUR LA HAUTEUR D'UN CHÂSSIS DE 1092mm*

Industries NRC, 2430 Principale, St-Paul d'Abbotsford, Qc, J0E 1A0, Canada

Date: 24 / 04 / 2025

Drawing - Dessin# 8905145